

The Challenge Machinery Company provides owner's manuals on its products solely as a courtesy to its customers. See the information below before using this manual.

These manuals are for reference only. These manuals include products which are noncurrent, unsupported or no longer produced by The Challenge Machinery Company, and are provided solely as an accommodation to our customers. By providing these manuals, The Challenge Machinery Company makes no representation or warranty as to the products, their current condition, or their suitability or fitness for use in any particular application, which are the sole and independent responsibility of the product owner and user.

**Older products may not comply with current safety procedures, guidelines or regulations, and it is the product owner's and user's responsibility to evaluate the suitability and fitness of the products in their current use and application. The Challenge Machinery Company makes no representation, warranty or recommendation regarding any modifications which may be required on non-current or unsupported products. The Challenge Machinery Company assumes no liability for any modification or alteration to any Challenge product, and any such modification or alteration to any Challenge product is not authorized by The Challenge Machinery Company.** The availability of these manuals is solely for the purpose of providing reference information for the products.

This manual may not be complete in all aspects of product maintenance and repair. **All products should be used only by qualified and properly trained personnel, following proper safety procedures.** All products should be regularly inspected and maintained, and their condition, application and use should be periodically evaluated by qualified personnel. Only qualified and properly trained technicians should perform maintenance, repair and replacement procedures. Attempting these procedures without proper training may cause machine damage or operator injury!

Products may be unsupported by The Challenge Machinery Company due to age or the unavailability of parts from their original manufacturer. No parts or product support will be available to repair or maintain unsupported products. Older products may not be UL listed (if the product does not have a UL label it is not a listed product), and may not comply with applicable installation or other regulations or requirements if relocated to a new facility. Many municipalities require a product to be UL listed before an electrician will connect power to them. Often the cost of updating an older product to comply with current safety regulations is greater than the value of the product.



**The Challenge Machinery Company**  
6125 Norton Center Drive  
Norton Shores, MI 49441-6081 USA

ChallengeMachinery.com

## ***SPARTAN 150 M***

### ***Operator's Manual***

**Serial Numbers:**  
041001 through 159999,  
150M-A-150000 and up

*Sold and Serviced by*

**F.150M-O**  
August 2015

# 1.0 Introduction

---

THIS MANUAL is designed to help you get the most from your Challenge equipment. Keep this manual in a safe, convenient place for quick reference by operators and service personnel.

## **▲▲ CAUTION**

**SAFETY ALERT!** This symbol means **CAUTION: Personal safety instructions!** Pay special attention to the instructions in bold type. Personal injury may result if the precautions are not read and followed.

**READ THIS MANUAL BEFORE OPERATING!** Follow precautions and instructions. If after reading the manual, questions remain, please contact your Authorized Challenge Dealer.

Take a few minutes right now to **RECORD YOUR MACHINE SERIAL NUMBER** in the space provided on the front cover of this manual. Also be sure to fill out the warranty card accompanying your machine and return it **DIRECTLY TO CHALLENGE**.

If you bought a used machine, it is important to have the following information on record at Challenge. Copy this page, fill in the information and send it care of The Challenge Service Department, 6125 Norton Center Drive, Norton Shores MI. 49441.

CHALLENGE MODEL Spartan 150 M	SERIAL NUMBER	
ATTN	COMPANY	
ADDRESS		
CITY	STATE/PROVINCE	ZIP
PHONE	DATE INSTALLED	
DEALER NAME & CITY		

### **\* WARRANTY INFORMATION \***

It is very important that you read and understand the conditions outlined in the *Warranty Information Sheet* attached to the outside of the shipping container of your machine.

The *Warranty Information Sheet* must be filled out completely and returned to THE CHALLENGE MACHINERY COMPANY in order for the warranty to be issued for this machine.

Challenge® is a registered trademark of  
The Challenge Machinery Company • 6125 Norton Center Drive • Norton Shores MI. 49441  
Copyright© 2004 by The Challenge Machinery Company. All rights reserved. Printed in the U.S.A

---

**TABLE OF CONTENTS**

1.0 Introduction .....	2
2.0 Safety .....	4
2.1 Precautions .....	4
2.2 Power Lockout Procedure .....	4
2.3 Warning Label Definitions .....	5
3.0 Packing List .....	7
4.0 Specifications .....	8
5.0 Installation & Setup .....	9
5.1 Inspecting Shipment .....	9
5.2 Uncrating .....	9
5.3 Cleaning .....	9
5.4 Power Hook-Up .....	9
5.5 Mounting to Optional Stand .....	9
6.0 Operation .....	10
6.1 Main Power .....	10
6.2 Backgauge Control .....	11
6.3 Jogging Aid .....	12
6.4 Line Light .....	13
6.5 Making a Cut .....	13
6.6 Adjusting the Knife Depth .....	13
6.7 Operating Tips .....	14
7.0 Knife Installation/Changing .....	15
7.1 Knife Removal .....	15
7.2 Knife Installation .....	16
7.3 Knife Care Tips .....	17
7.3.1 Knife Blade Life .....	17
7.3.2 Cutting Stick .....	17
7.3.3 Bevel Angle .....	18
7.3.4 Helpful Suggestions .....	18
7.3.5 Knife Care .....	18
8.0 Footprint .....	19
9.0 Safety Systems Test .....	20

## 2.0 Safety

---

### 2.1 Precautions

- This machine is designed for one-person operation. Never operate the machine with more than one person.
- Safe use of this machine is the responsibility of the operator. Use good judgment and common sense when working with and around this machine.
- Read and understand all instructions thoroughly before using the machine. If questions remain, contact the dealer from which you purchased this machine. Failure to understand the operating instructions may result in personal injury.
- Only trained and authorized people should operate this machine.
- **DO NOT ALTER SAFETY GUARDS OR DEVICES.** They are for your protection. Severe personal injury may result.
- **Disconnect power** before cleaning or performing maintenance. See Section 2.2 Power Lockout Procedure.
- Observe all caution labels on this machine.
- Be sure the cutter is properly grounded.
- Be sure there is sufficient power to operate the cutter properly.
- Observe all caution plates mounted on this cutter.
- Keep foreign objects off table and away from cutter blade.
- **BE EXTREMELY CAREFUL** when handling and changing the cutter knife. Severe lacerations or dismemberment could result from careless handling procedures.
- Keep the floor around the cutter free of trim, debris, oil and grease.
- When replacing hydraulic parts, loosen the connections slowly to release pressure. Never loosen connections with the machine running.
- If the cutter sounds or operates unusually, have it checked by a qualified service person.
- **CRUSH HAZARD**, keep hand and fingers from under the clamp when clamping paper. Use Jogging Aid to load paper, and use the backgauge to push paper out before unloading. **DO NOT REACH UNDER THE KNIFE AND CLAMP AREA!**

### 2.2 Power Lockout Procedure

For maximum safety while making adjustments or repairs to your machine, be sure to disconnect power to the machine. Disconnect the power plug from its socket.

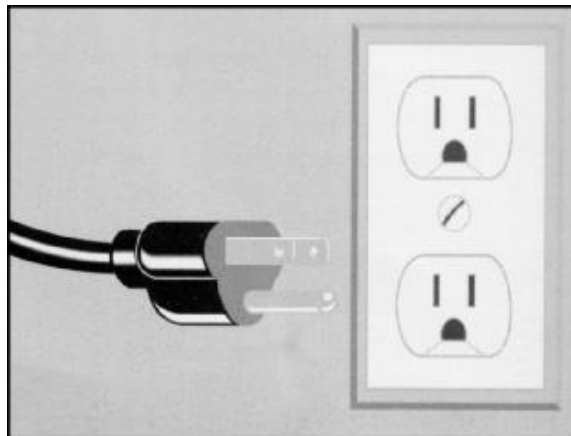

Figure 1 - Main Power Disconnect

## 2.3 Warning Label Definitions

The following warning labels are found at various locations on your machine. Read and understand the meaning of each symbol. If a label is lost from the machine, it should be replaced.



### **HAZARDOUS AREA**

Disconnect power before cleaning, servicing, or making adjustments not requiring power. Do not alter safety guards or devices; they are for your protection. Replace all guards. Do not operate with any guards removed.

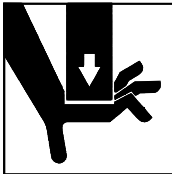

### **CUT/CRUSH HAZARD**

Keep hands from underneath the knife and clamp.



### **SINGLE OPERATOR**

Do not operate with more than one person.

# !OJO!

## CAUTION

This Este simbolo de alerta de seguridad significa ¡ OJO ! - INSTRUCCIONES DE SEGURIDAD PERSONAL. Lea las instrucciones porque se refieren a su seguridad personal. Fall de obedecer las instrucciones que siguen podria resultar en lesiones corporales.

- Esta maquina, junto con sus mecanismos de seguridad, esta disenada para ser manejada por
- **UNA SOLA PERSONA** a la vez. Jamas debe ser manejada por mas de una persona al mismo tiempo.
- La seguridad es la responsabilidad del operario que usa esta maquina.
- **LEA DETENIDAMENTE** el manual de instrucciones y las **PRECAUCIONES DE SEGURIDAD** antes de poner a funcionar la cortadora. Pidale a su supervisor una copia.
- El manejo de la guillotina debe estar exclusivamente a cargo de personal entrenado y autorizado para ello.
- **NO MODIFIQUE LOS MECANISMOS DE SEGURIDAD**, estan ahi para su proteccion no deben ni modificarse ni quitarse.
- **DESCONECTE LA CORRIENTE ELECTRICA** antes de proceder a hacerle servicio de limpieza, engrasar, o de hacer ajustes que no requieren corriente. Trabe el interruptor en la posicion **OFF** (apagado); vea "Procedimiento para cortar la corriente electrica" al pie de esta pagina.
- Eche llave a la guillotina y quite la llave cuando la maquina no esta en operacion; vea "Corriente electrica".
- Asegurese de que la guillotina este debidamente a tierra. Vea "Conexion de la fuerza electrica".
- Verifique el voltaje y asegurese de que este sea suficiente para el debido funcionamiento de la guillotina.
- Preste atencion a todas las placas con advertencias instaladas en esta guillotina.
- No permita que objetos estranos esten en la mesa o cerca de la cuchilla cortadora.
- **TENGA SUMO CUIDADO** al tocar y cambiar la cuchilla. Heridas severas y hasta desmembramiento pueden resultar del manejo sin cuidado o negligente.
- El suelo alrededor de la guillotina debe mantenerse despejado y libre de recortes, desperdicios, aceite y grasa.
- Al haber la necesidad de reemplazar partes hidraulicas, afloje todas las conexiones poco a poco para dejar escapar la presion. Jamas debe aflojarse conexiones mientras la maquina este andando.
- Si la guillotina empezara a sonar o trabajar diferentemente a lo acostumbrado, desconectela y consulte la seccion "Troubleshooting" (Reparador) de este manual. Si no es posible corregir el problema, llame a su servicio autorizado para que le examinen la maquina.
- **PELIGRO DE MACHUQUE** - Mantenga manos y dedos fuera de la agarradera mientras sujeta el papel. Use el calibrador trasero y su rueda de mano para empujar el papel cortado. **NO PONGA SUS MANOS BAJOLA CUCHILLA O AREA DE LA AGARRADERA.**
- **NO OPERE SIN LAS GUARDAS PROTECTORAS!**

## ¡ OJO ! PRECAUCION - Como proceder para desconectar la corriente electrica.

Para maxima seguridad durante ajustes y reparaciones de su maquina, verifique bien que el interruptor principal de control de corriente al cual la maquina esta conectada, este desconectado. El interruptor deba ser puesto en la posicion "OFF" (desconectado) y se debe poner un candado en la anilla. La llave del candado debe ser guardada por la persona que estara efectuando los trabajos de servicio o de reparacion en la guillotina.

Desconecte la corriente electrica antes de proceder a hacer cualquier ajuste o reparacion o de efectuar el engrase en cualquier maquina.

## 3.0 Packing List



Part No.	Description	Qty.
Spartan 150 M	15" Digital/Lever Paper Cutter	1
60011-2	Knife – Standard (installed in machine)	1
60057	Cutting Stick	1
F.150M-O	Operator Manual	1
60058	Jogging Aid	1
60061	Knife Lifter Assembly	1
61036	Lever Handle	1
5064	Cut Stick Puller	1
W-189	5/32" Hex 'T' Allen Wrench	1
W-190	1/8 Hex Wrench- Short Arm	1

## Optional Items

Part No.	Description	Qty.
60057	Extra Cutting Sticks	1
60011-2	Knife – Standard	1
60011-1	Knife – Long Lasting H.S.S.	1
61070	Stand	1

# 4.0 Specifications

Description	Inch Units	Metric Units
Cutting Width	15-3/4"	40 cm
Minimum Cut	1-15/16"	4.9 cm
Clamp Opening	1-1/2"	3.8 cm
Table Space		
Front:	6-1/4"	15.9 cm
Back:	15-1/4"	38.7 cm
<b>Dimensions</b>		
Overall Height	12-1/2"	31.8 cm
Overall Height with Optional Stand	45-1/4"	115 cm
Table Height with Optional Stand	36"	91.4 cm
Overall Length	27-1/4"	69.2 cm
Overall Width	28-1/8"	71.4 cm
Approx. Net Weight	80 lbs	36 kg
Approx. Shipping Weight	110 lbs	50 kg
Approx. Weight of Optional Stand	60 lbs	27 kg
<b>Electrical</b>		
120 Volts 60 HZ. 11 W, Service Size 15 Amps		
<b>Sound Emission</b>		
N/A		

Challenge reserves the right to make changes to any product or specification without notice and without incurring responsibility to existing units.

---

## 5.0 Installation & Setup

---

### 5.1 Inspecting Shipment

This machine has been carefully packed to prevent damage during shipment. However, claims for damage or loss are the responsibility of the recipient. Inspect all shipments as soon as they are received. If there is any noticeable damage, note it on the freight bill. Visual and/or hidden damage must be reported to the claims department of the carrier within 15 days. Contact your dealer if you need any assistance. Check the contents of the box against the packing list on page 7. Make sure there are no missing items.

### 5.2 Uncrating

The Spartan 150 weighs approximately 80 lbs (36 kg). DO NOT risk personal injury or damage by attempting to move machinery with makeshift equipment or inadequate help. This machine is shipped on a wooden skid and enclosed in a protective, wooden frame and corrugated carton. Remove the carton by removing the nails or staples holding it to the wooden frame and lift it straight up over the cutter. Remove the wooden uprights and cut the plastic straps. Carefully lift machine off skid and set on to work surface or optional stand (see section 5.5 Mounting to Optional Stand). Screw the lever handle onto the cutting lever.

### 5.3 Cleaning

After unpacking, wipe down all machine panels and surfaces with a clean cloth.

### 5.4 Power Hook-Up

**▲▲ CAUTION** **SHOCK HAZARD!** Possible shock could cause personal injury or death. Connect A/C adapter to any standard 120 Volt outlet. Have a qualified electrician install one if your location is not so equipped. The socket-outlet shall be installed near the machine's location and be easily accessible.

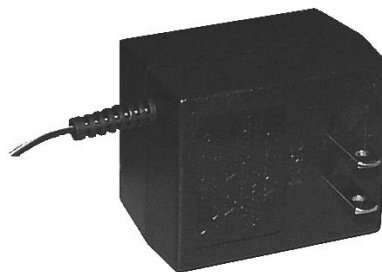

Figure 2 – A/C Adapter

### 5.5 Mounting to Optional Stand

Place the machine on the stand. No portion of the machine base should overhang the top shelf of the stand. If it does, rotate the machine 90° and place it back on the stand. Line up two holes in the top shelf of the stand with two holes on the underside of the machine base. Fasten the machine to the stand using two 1/4 –20 screws provided with the stand. These screws are used to prevent the machine from tipping over while cutting.

# 6.0 Operation

**▲ CAUTION** IMPORTANT: DO NOT ATTEMPT TO OPERATE THE CUTTER UNTIL YOU HAVE THOROUGHLY READ AND UNDERSTAND ALL OF THE FOLLOWING INSTRUCTIONS. CALL YOUR AUTHORIZED CHALLENGE DEALER IF YOU STILL HAVE ANY QUESTIONS.



Figure 3 – Machine Controls

## 6.1 Main Power

Power is enabled when the A/C adapter is plugged in and when the connector is plugged into the socket at the back, left table (Figure 4). The display and line light are switched on at this time.



Figure 4 – Connect Power to the Machine

## 6.2 Backgauge Control

The backgauge is used to position paper to the desired location when cutting. The backgauge is operated by the hand crank at the front of the machine. The backgauge position is shown by a lighted LED display. When the machine is first powered up, the display shows four lines as follows, indicating the display needs to be reset.

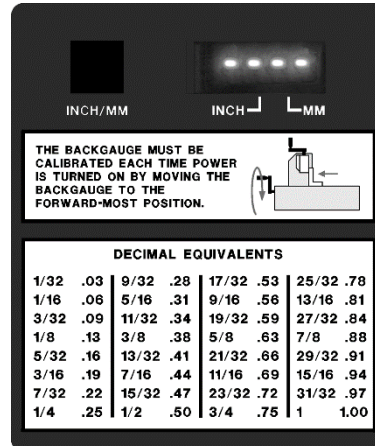

Figure 5 – Display at power up

To reset the display, bring the backgauge to the forward most position. If the backgauge is already at the forward most position, move the backgauge back by a few turns, then bring it forward again. Now the display should show the actual position of the backgauge (Figure 6). If the machine is left on all of the time, this should be done at least once per day. The position of the decimal point indicates whether the reading is in inches or millimeters. Two digits to the right of decimal indicates inches, one digit to the right of decimal indicates millimeters. To switch from inches to mm and vice-versa, press the inch/mm button located next to the display.

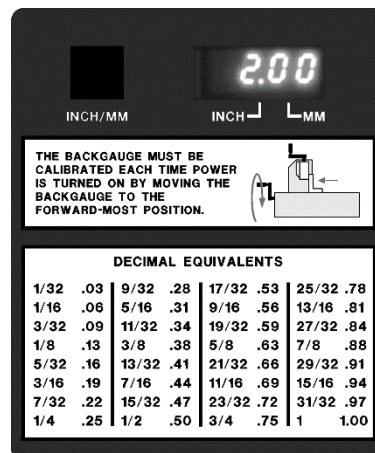

Figure 6 – Display with backgauge at 2.00 inches

### 6.3 Jogging Aid

**▲▲ CAUTION**

Always remove the jogging aid from the table before making a cut.

A jogging aid is included as standard equipment with the Spartan 150. This tool allows the operator to load and align paper without the need to place hands or arms under the knife or clamp.

To use, load the paper against the side and backgauge using the jogging aid (Figure 7 & Figure 8). Remove the jogging aid from the table, close the shield, clamp the paper, and make the cut.

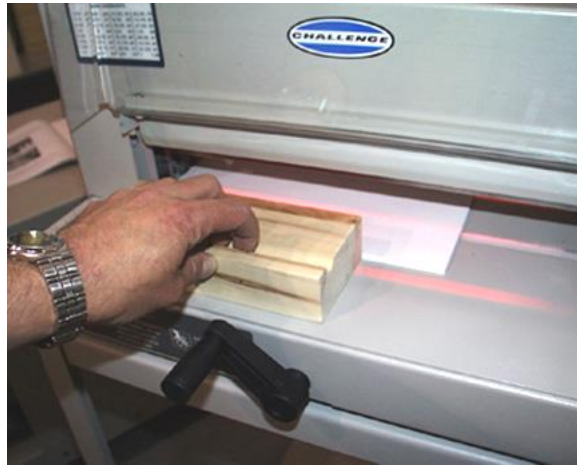

Figure 7



Figure 8

## 6.4 Line Light

The Spartan 150 comes standard with an LED line light. The line light switches on and stays on whenever the power is on. To use, simply align paper under clamp, and use the red light line as an indicator of where the cut will be made (Figure 9).



Figure 9 – Line Light

## 6.5 Making a Cut

Open the front shield and set the backgauge to the desired position. Place the paper square against the backgauge and either side guide. Clamp down on the paper using the clamp hand-wheel located on top of the machine. Close the front shield. Move the red-capped knife latch lever and pull the cutting lever to the left. Once the cutting lever has moved slightly, the knife latch lever may be released. Two hands may then be used to complete the cut. Firmly seat the knife into the plastic cutting stick to assure all sheets are completely cut. If all sheets are not completely cut see 6.6 Adjusting the Knife Depth to adjust the cutting depth. Move the cutting lever to its original position and raise the hood. **The hood will not open unless cutting lever is at its right-most position.** Raise the clamp by turning the hand-wheel and remove the cut pieces of paper.

## 6.6 Adjusting the Knife Depth

The depth of cut can be adjusted using the knife depth adjusting screw located on the left side of the machine. The same T-handled wrench used for changing the knife can be used to adjust the screw. Turn the screw counter-clockwise to increase knife depth, and clockwise to decrease knife depth. It is better to make several slight adjustments and perform test cuts in between, than to make large

## 6.0 Operation

---

adjustments and cut too deep. Try to avoid setting the knife too deep because this can cause premature wear on knife and/or damage the cut stick.



**Figure 10 – Knife Depth Adjustment**

## 6.7 Operating Tips

Carefully lay out each sheet before you start cutting. Find the best cut pattern to give you the most pieces out of the sheet. If the sheet will be folded, be sure grain of the paper is running in the same direction as the fold or you will get a rough edge on the fold.

If an accurate cut is necessary for close register work, you **MUST** have a sharp blade in the cutter. A dull blade will pull or draw the paper and cause uneven cutting. Increased clamp pressure will not eliminate draw caused by a dull knife.

The correct clamping pressure varies from paper to paper. The general rule is that you should have enough pressure to hold the paper securely but not so much that it marks the surface of the paper excessively. Excessive pressure causes pile distortion and inaccurate cuts.

Mark the gripper edge and the guide edge of printed paper and make sure the first cuts are with these guide edges against the backgauge.

When cutting business cards or narrow strips of paper, place lifts of equal height on opposite sides of the table to provide better clamping.

## 7.0 Knife Installation/Changing

### ▲▲ CAUTION

Changing knives can be very dangerous unless safety precautions are observed and extreme care is taken when handling knives.

- Make sure knife lifters are used properly, see instructions following.
- Keep handling of unprotected knives to an absolute minimum.
- Clear off cutter table before removing knife.
- Have scabbard nearby and insert knife immediately.
- Warn people of any unprotected knife.
- Knife changing is a **ONE PERSON OPERATION**. Having more than one person trying to change knives invites accidents.

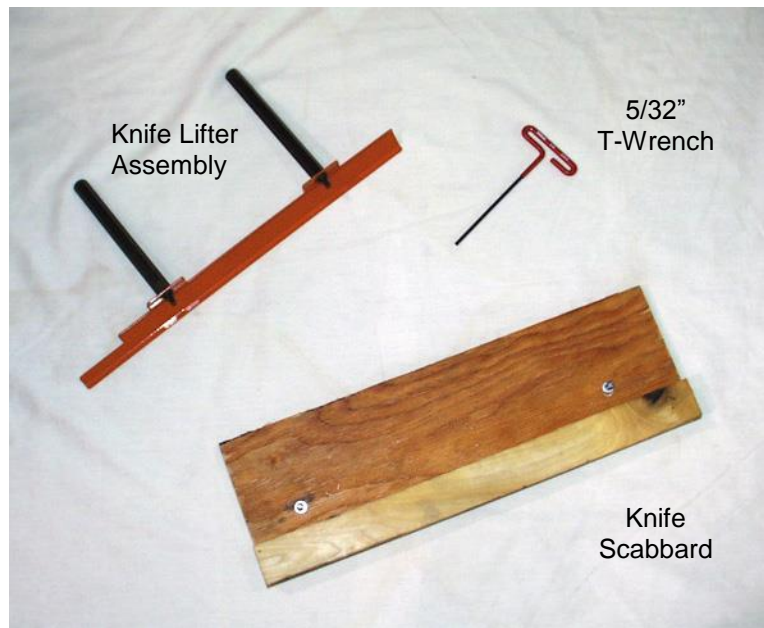

Figure 11 – Spartan 150 Knife Change Accessories

The knife changing equipment shown in Figure 11 is included with the machine. The following instructions show how to remove and install a new or re-sharpened knife. Read these instructions AT LEAST ONCE before attempting to actually change or install any blades.

### 7.1 Knife Removal

#### ▲▲ CAUTION

Knives are always very sharp! Be sure to keep the edge away from your body and keep other people out of the area while handling the blade. Severe lacerations or dismemberment could result from careless handling procedures.

1. Lower the clamp to the table and remove the clamp handle and cutting lever handle.
2. Remove the top cover.

## 7.0 Knife Installation/Changing

---

3. With the knife at its extreme up position, lift the hood.
4. Remove the two knife bolts that are mounted in open slots in the knife bar.
5. Install the knife lifter onto the knife holder. Screw the handles into the holes from which the two, knife bolts were removed. Firmly tighten each handle.
6. Remove the remaining knife bolts.
7. Place an empty knife scabbard on a nearby flat surface.
8. Slowly loosen the handles until the knife can be freed from the knife bar. Move the knife to the right or left and remove it from the machine at an angle.
9. Place the knife on the scabbard and remove the knife lifter. Carefully slide the knife to line up holes in the knife with holes in the scabbard. Secure the knife to the scabbard using the scabbard screws.
10. Send dull knives to a knife grinder – do not attempt to sharpen your own knives! Knives that do not have a minimum height of 1-1/2" (3.8 cm) will not function properly and should be carefully discarded. See the Knife Care Tips Section below for additional information.

## 7.2 Knife Installation

### CAUTION

Knives are always very sharp! Be sure to keep the edge away from your body and keep other people out of the area while handling the blade. Severe lacerations or dismemberment could result from careless handling procedures.

1. If a knife is currently installed or the top cover is installed, see the previous section for instructions on knife removal. The clamp should be lowered to the table. The clamp handle and top cover should be removed from the machine.
2. Raise the hood. Pull out the cut stick and turn it to a new surface or replace with a new one.
3. Remove the retainer screws from the new blade and screw the knife lifters into the new blade. Screw the lifters about half way into the knife.
4. Insert the knife assembly into position under the knife bar. Raise the knife into the knife bar slot as high as it will go. Check all view holes to make sure knife is all the way up. Tighten the lifters.

**NOTE:** If the blade will not go in, make sure the lifters are not screwed into the blade too far.

5. Insert and tighten (4) knife bolts into the knife.
6. Loosen the knife lifter handles and remove the knife lifter.
7. Insert and tighten the remaining (2) knife bolts.
8. Reinstall the top cover, clamp handle, and lever-arm handle.
9. Adjust depth of cut by placing sheets of paper across the entire width of the cutting area. Clamp the paper and make a cut. Adjust the knife depth adjustment screw just until the

entire width of paper is cut completely through. Do not allow the knife to cut too deep into the cut stick. Cutting excessively deep into the stick will reduce its life.

10. Send dull knives to a knife grinder – do not attempt to sharpen your own knives! Knives that do not have a minimum height of 1-1/2" (3.8 cm) will not function properly and should be carefully discarded. See the Knife Care Tips Section below for additional information.

## 7.3 Knife Care Tips

**▲▲ CAUTION ! KNIFE SAFETY !** Knives are **DANGEROUS!!!** Knives are very sharp, even after use. Keep the edge away from your body and keep the area clear of others when handling knives. Never touch the cutting edge! To prevent personal injury and damage to the knife, always keep knives in their holders with screws tightened. Even if you are aware of the dangers, others may not be. Never attempt to hone, polish, or service the knife in any way. Failure to follow safety procedures may result in severe lacerations or dismemberment.

### 7.3.1 Knife Blade Life

Knife blade life, or the time between sharpening, can be affected by many factors. One important factor is the type of paper being cut. Abrasive paper, such as recycled paper, soft paper such as newsprint and bound books can all significantly shorten knife blade life. In addition, if the knife depth is set too deep, the knife will cut too deep into the cutting stick and can quickly dull the knife blade.

A knife can last between 2,000 and 5,000 cuts before it needs to be sharpened. Cutting soft paper (such as newsprint paper) or paper with high post-consumer recycled content can cause the knife to need sharpening after only 2,000 to 3,000 cuts. Cutting pure paper, such as bond paper with no recycled content or hard paper can allow the knife to be used for as many as 5,000 cuts before it needs to be sharpened. In all cases, the operator should continually check the quality of the cut to determine when the knife blade needs to be sharpened. Some characteristics that indicate a blade needs sharpening are:

- The cut requires too much effort.
- The sheets are not all cut to the same length (usually the top few sheets are longer than the rest of the sheets - this is sometimes called "draw").
- Cut marks or scoring appears on the cut face of the paper.
- The profile of the cut (side view) is not perpendicular to the table.
- The cut does not appear straight when viewed from the top.
- The knife makes a "rough" sound as it passes through paper.
- Nicks are visible on the cutting edge of the knife.

### 7.3.2 Cutting Stick

A worn cutting stick can affect the cut quality of the bottom sheets. When this happens, the cut stick can be rotated. Usually, the stick should be rotated one or two times between knife sharpening. Cut sticks have a "wavy" shape to them and when rotated must be rotated a full 180° to keep a flat side up. Each stick has 2 flat sides that can be used, after which it can be turned end to end, allowing the 2 flat sides to be used again, for a total of 4 positions per cut stick.

### 7.3.3 Bevel Angle

Challenge recommends that the bevel angle for the Spartan 150 knives be 20°. Order a re-sharpened knife to the following specification, “20°, DEAD SHARP, NO MICRO-BEVEL.” A micro-bevel on this knife will cause strenuous cutting. If an operator requires cutting with less physical strain, knives may be re-sharpened to 18°. Note, however, that a knife sharpened at 18° has a shorter lifetime and is more susceptible to damage.

### 7.3.4 Helpful Suggestions

- It may be helpful to own a “set” of knives. A set consists of 3 knives: one in the machine, one as back up, and one at the grinder.
- If the machine seems to strain but the cut quality is still good, reduce the pile height. You may also carefully apply glycerin to the bevel when cutting hard, coated paper. Tie a cloth to the end of a stick; dip the stick in glycerin, and apply. Never apply by hand! In lieu of glycerin, you may lightly rub white bar soap along the bevel. Lubrication will prolong the life of your machine and reduce maintenance.

### 7.3.5 Knife Care

- To prevent corrosion, new knives are coated with light oil. It should be REMOVED WITH CARE.
- While removing or installing a knife, be careful not to allow the edge to bump against the machine. Nicks will result.
- If a knife bolt is damaged, replace it.
- Always keep knife bolts securely tightened.
- Store knives in a dry environment to prevent corrosion.
- Never attempt to service a knife in any way.

# 8.0 Footprint

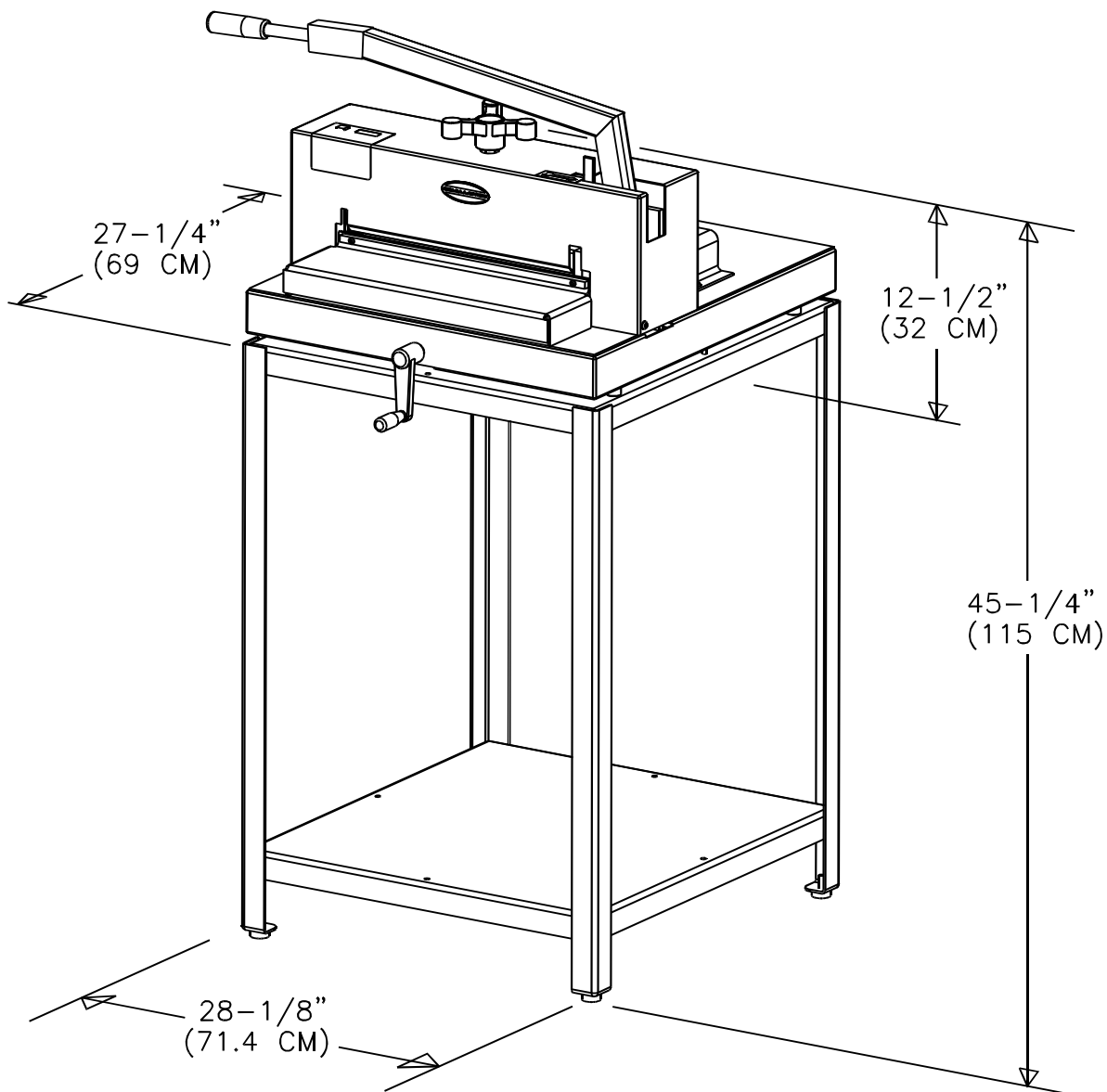

## 9.0 Safety Systems Test

---

Machine manufacturer CHALLENGE

Model SPARTAN 150 M

Serial Number \_\_\_\_\_

Frequency of test: **THESE TESTS SHOULD BE PERFORMED WEEKLY.**

Test #1: Move the cutting lever to its right-most position. Move the knife latch to the right and the cutting lever slightly to the left. Attempt to lift the hood. The machine requires service if the hood lifts more than approximately 1 inch. If the machine fails this test, do not use it until a qualified technician has serviced it. The knife interlock requires servicing.

Test #2: Move the lever arm to the left and release it at various locations. The lever should not move while it is not being held. If the lever moves after release, do not use it until a qualified technician has serviced it. The knife bar gibs require adjustment.



